

	A + B	C	B
800 x 800 x 2000	789 – 804	792 – 810	200
900 x 900 x 2000	889 – 904	892 – 910	300
1000 x 1000 x 2000	989 – 1004	992 – 1010	300
1100 x 1100 x 2000	1089 – 1104	1092 – 1110	400
1200 x 1200 x 2000	1189 – 1204	1192 – 1210	500
1200 x 800 x 2000	1189 – 804	792 – 810	500
1200 x 900 x 2000	1189 - 904	892 - 910	500

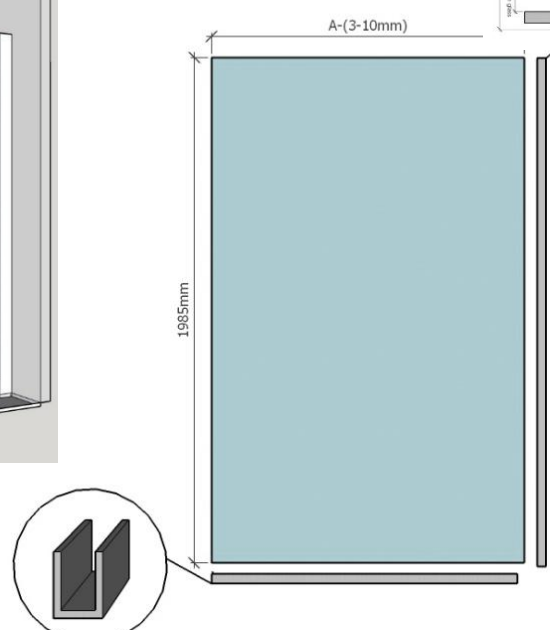

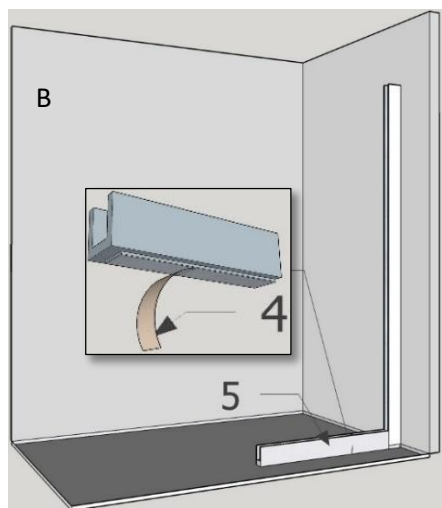

LEFT

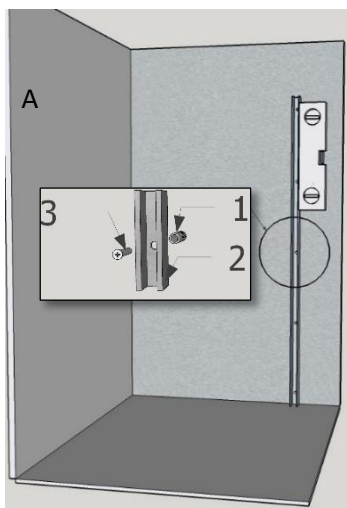
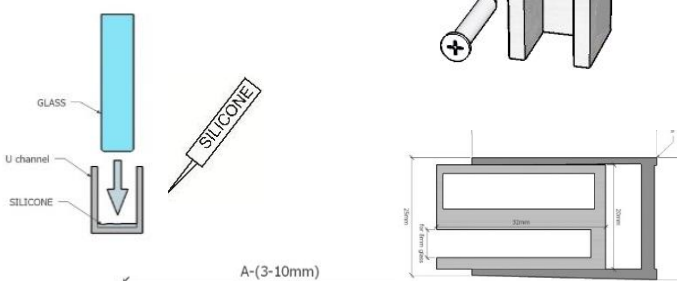
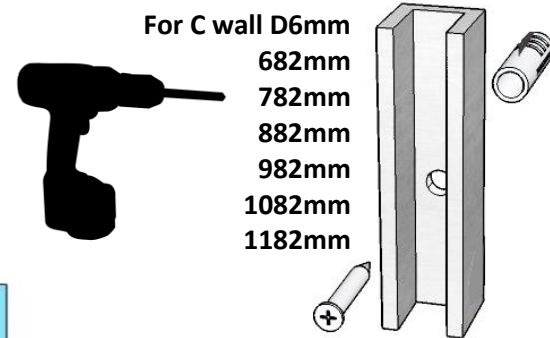
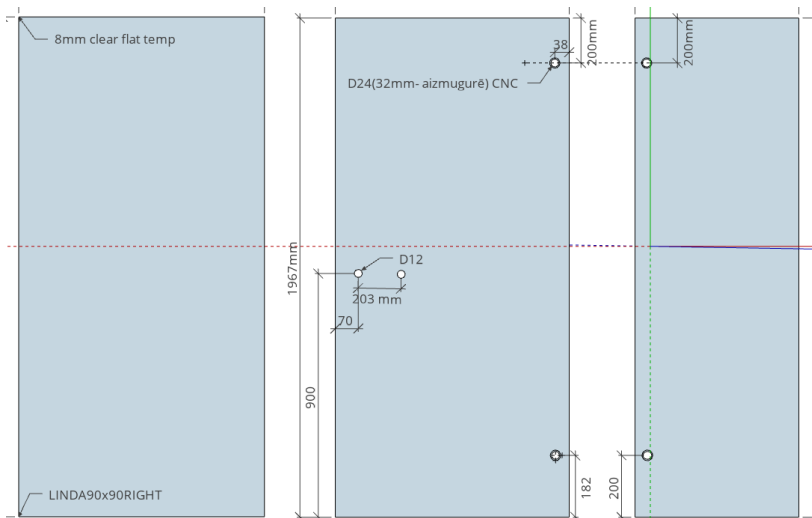
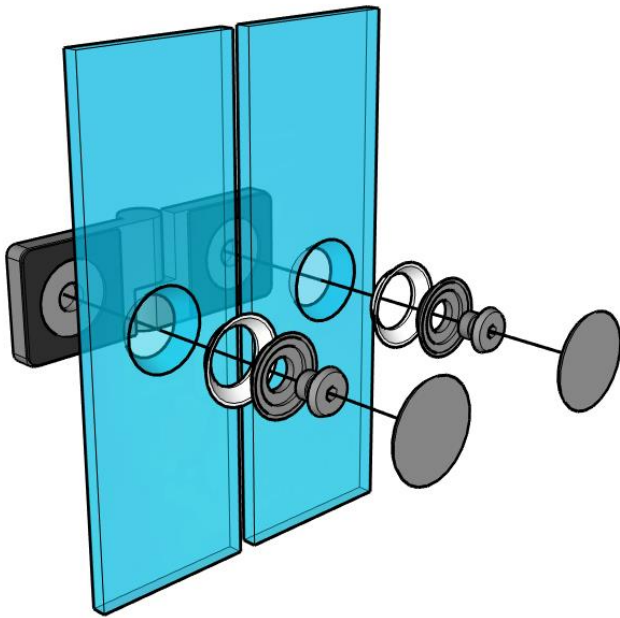
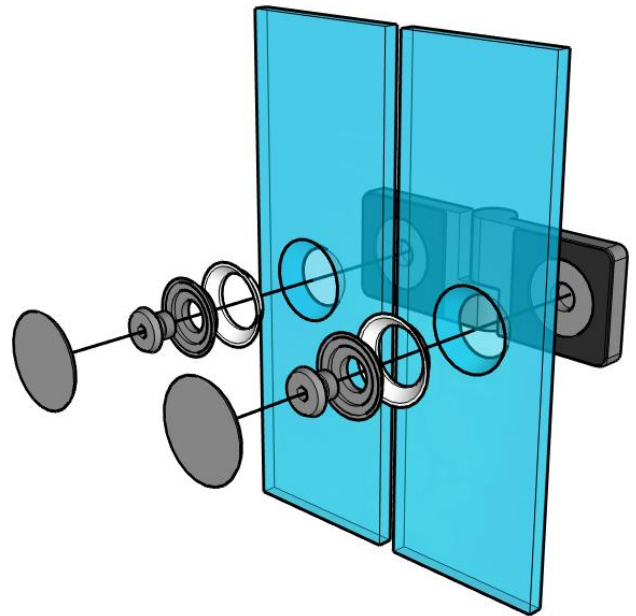

RIGHT

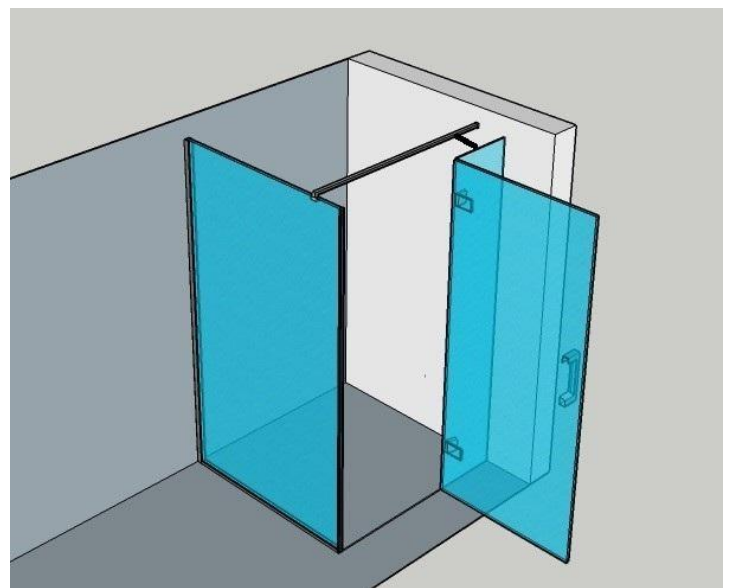
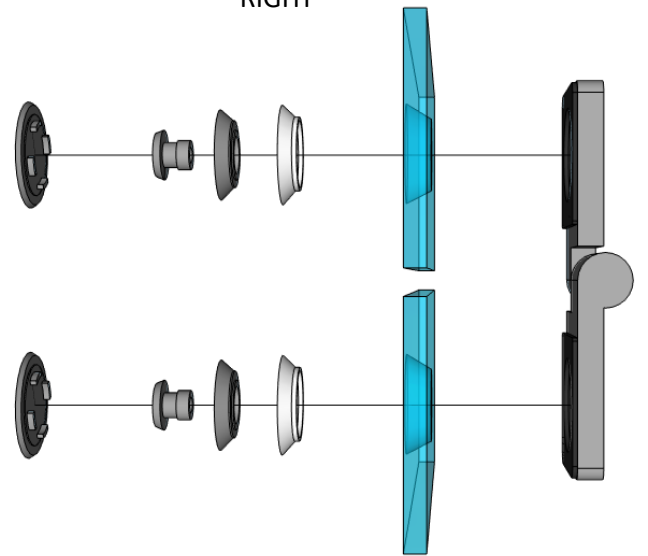
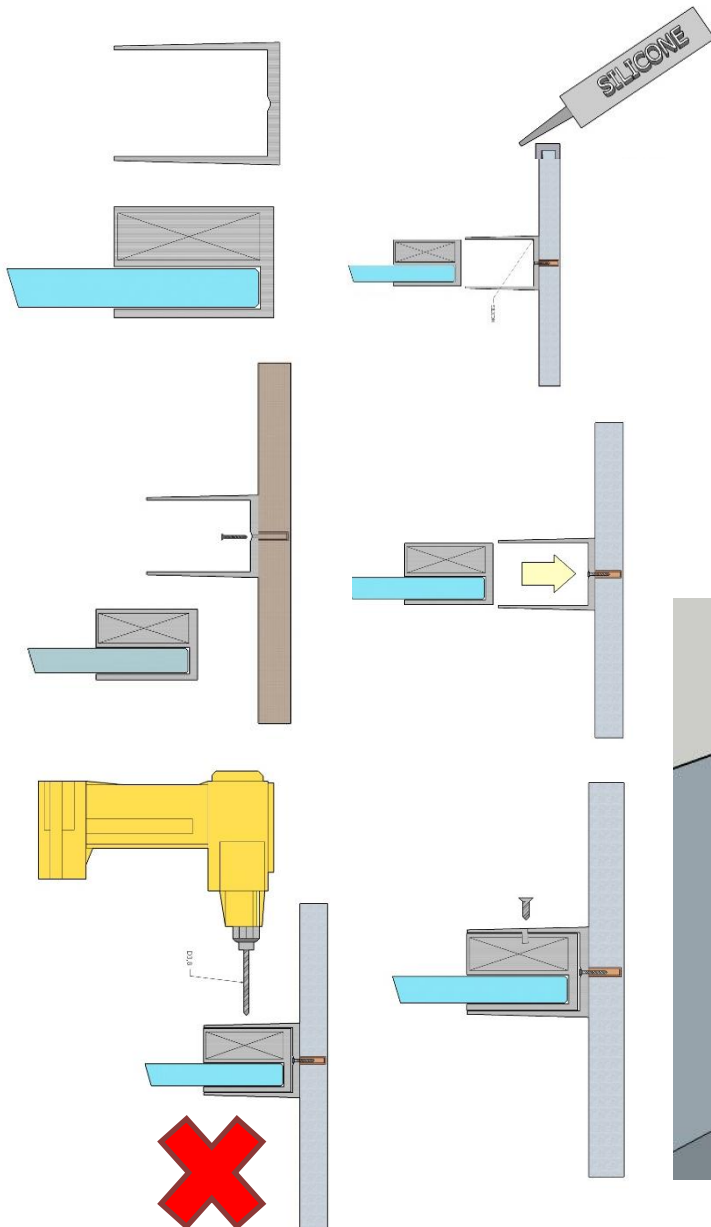

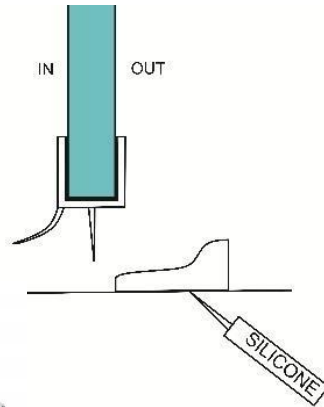
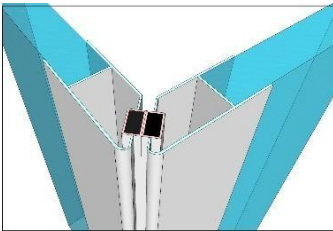
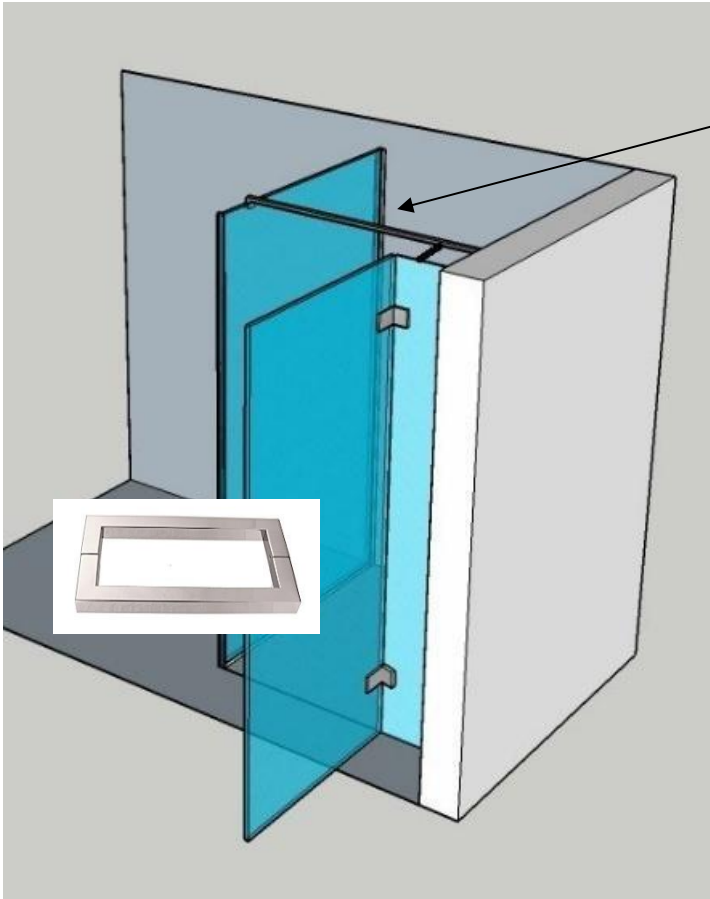

24

